

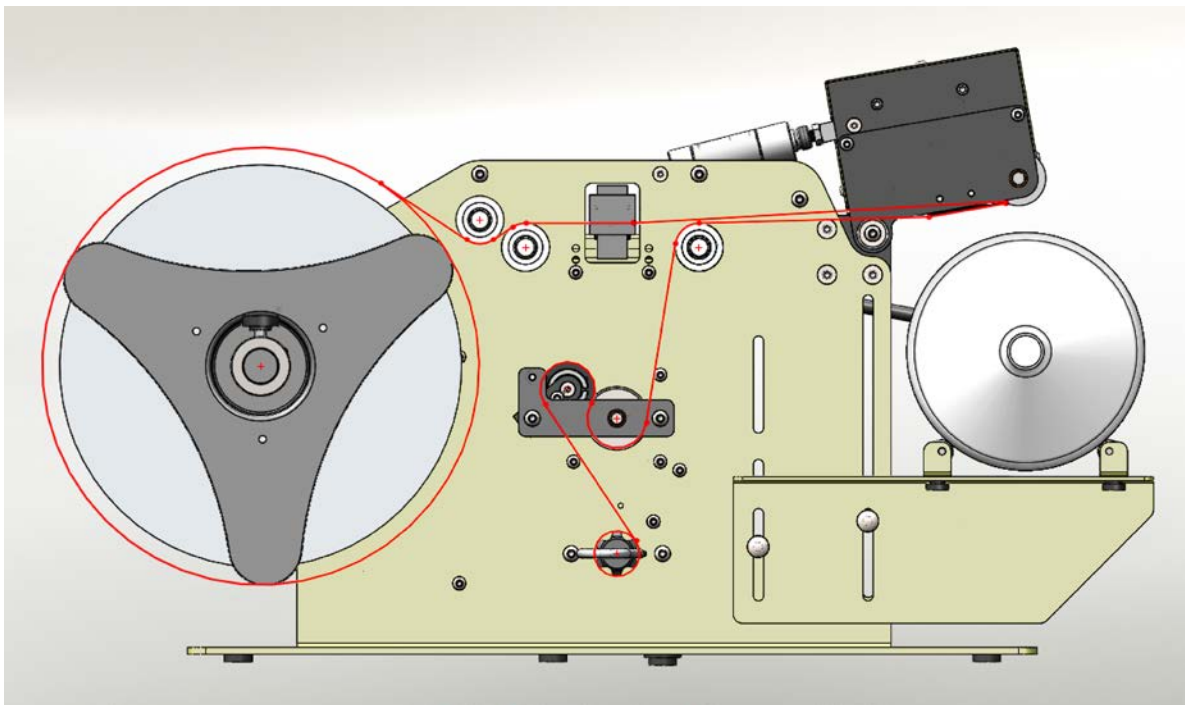

OPERATIONS MANUAL
MODEL TAL-3100R
ROUND PRODUCT LABEL
APPLICATOR



TAKE-A-LABEL®
16900 Power Dr.
Nunica, MI 49448
Phone: (616) 837-9300
Fax: (616) 937-9301
<http://www.take-a-label.com>
E-Mail sales@take-a-label.com



TAL-3100R Round Product Label Applicator

Machine Startup:

1. Unpack TAL-3100R Label applicator from shipping container.
2. Place the TAL-3100R on a firm level surface.
3. Plug the TAL-3100R into an 110VAC 10 AMP Grounded outlet.
4. Connect the labeler to a sufficient air supply. Minimum 80 PSI clean dry air.

Note: The TAL-3100R typically operates around 30 PSI depending on the label.

Label Threading:

1. Remove outer unwind disc (48) install new roll of labels and replace disc.
2. Pull label web under the first roller, throw the photo eye (14). Continue pulling the label web over the top of the next roller. Thread webbing between the peel edge and the rubber drive roller (30). Then back towards the supply roll, over the idler roller.
3. Pull web down and wrap under the drive roller (24), and up between the drive roller (24) and pinch roller (17), then back down to the waist wind shaft (5). Note: The pinch roller (17) is spring loaded. Slight pressure will be needed to separate the pinch roller from the drive roller for threading.
4. Install waist wind clip (47) on waist wind shaft (5) placing the webbing between the shaft and the clip.

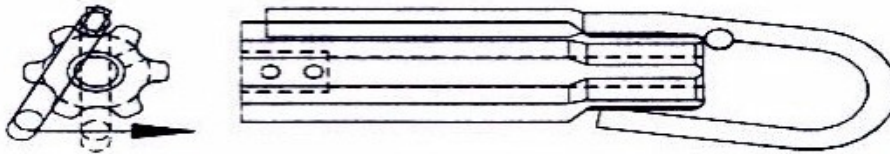



Teaching the photo eye:

1. It is recommended that you teach the photo eye (14) with every new roll of labels used.
2. Remove one label from the webbing and place the webbing only in the photo eye.
3. Press and hold the “Normal” button on photo eye for 3 seconds. When the lights finish flashing the photo eye is taught.





Label Setup:

The label advance potentiometer resides on top of the TAL-3100R electrical housing. The purpose is to adjust the stopping position of the label with respect to the peel plate. With the label advance pot turned all the way counterclockwise the photo eye will stop the applicator instantly when it senses a gap. By rotating the potentiometer toward the + the applicator will dispense more of the label, and by rotating the potentiometer toward the – the applicator will dispense less of the label.

1. To setup the label position, rotate the label advance pot to the – as far as it will rotate.
2. The goal is to have the applicator stop with a label gap right at the peel edge.
3. Activate the applicator and watch the dispensing label. If the label does not advance far enough turn the label advance pot to the +, and repeat until one label is completely dispensed and the next label is stopped at the peel edge.





Product Carriage Setup

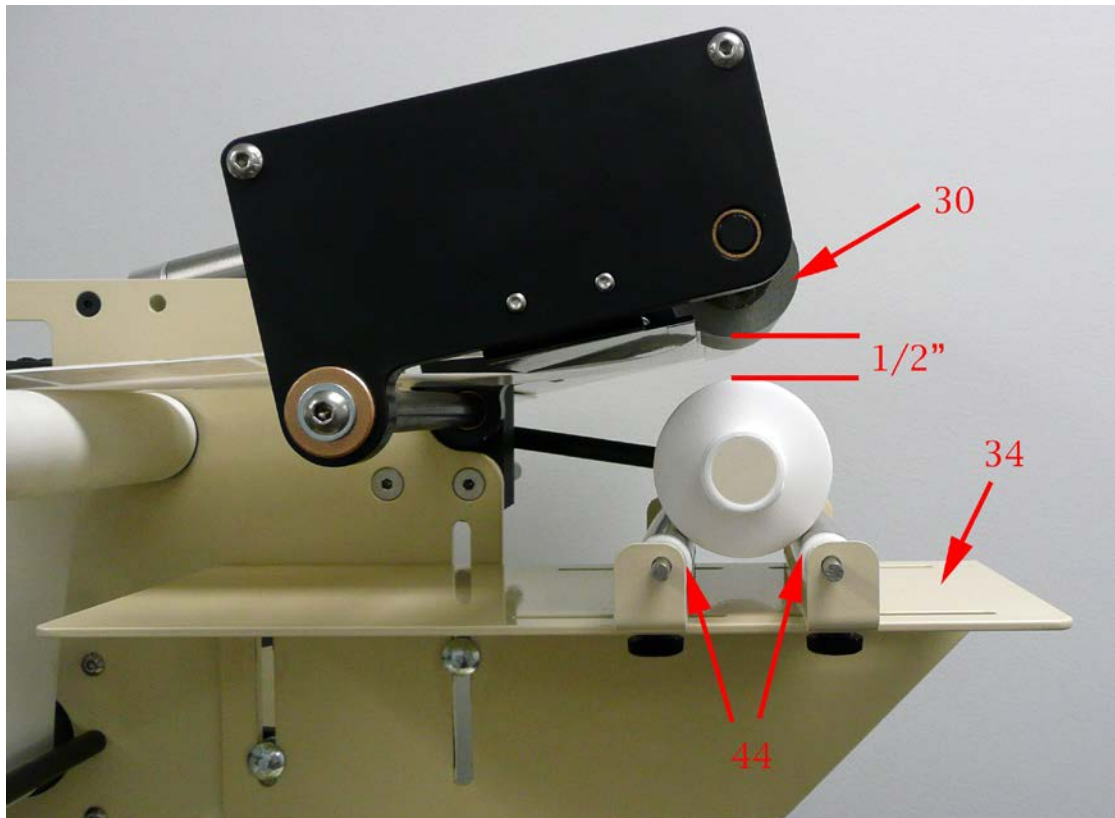

1. Keeping the product carriage table (34) level, raise or lower the product carriage by loosening the ratchet handles (2). Position the carriage with a ½" gap between the rubber traction roller (30) and the top of the bottle when the head is in the raised position.
2. Position the product rollers (44) with the center of the bottle under the rubber traction roller (30).
3. The product should be setting on the product rollers (44) so it will roll easily. If the label tends to “walk” to one side of the bottle during application, the product rollers (44) may need to be repositioned. Some products may even require one of the product rollers (44) to be slightly skewed.



Recommended Spare Parts List TAL-3100R:

Qty.	Description	Part #
1	Pinch Roller	31002
1	Waist wind Clip	45131
1	Drive V Belt	21031
1	Timing Belt	31834
2	Unwind Disc	45136
1	Label Drive Motor	76800
1	Feed Head Motor	31839
1	Rubber Drive Roller	31408
1	Foot Switch	30110
1	Air Cylinder	31806
1	Circuit Board	31255
3	Unwind Felt Pad	72618
1	Main Fuse	45157
1	Peel Edge Cover	31375
1	Valve Assembly	31805
1	Photo Eye	30106
2	Product Rollers	37007
2	Left Torsion Spring	21027
2	Right Torsion Spring	21028

Depending on frequency of use and importance of the machine function, this list may need to be modified to include more of each part to prevent any down time.

TAKE A LABEL

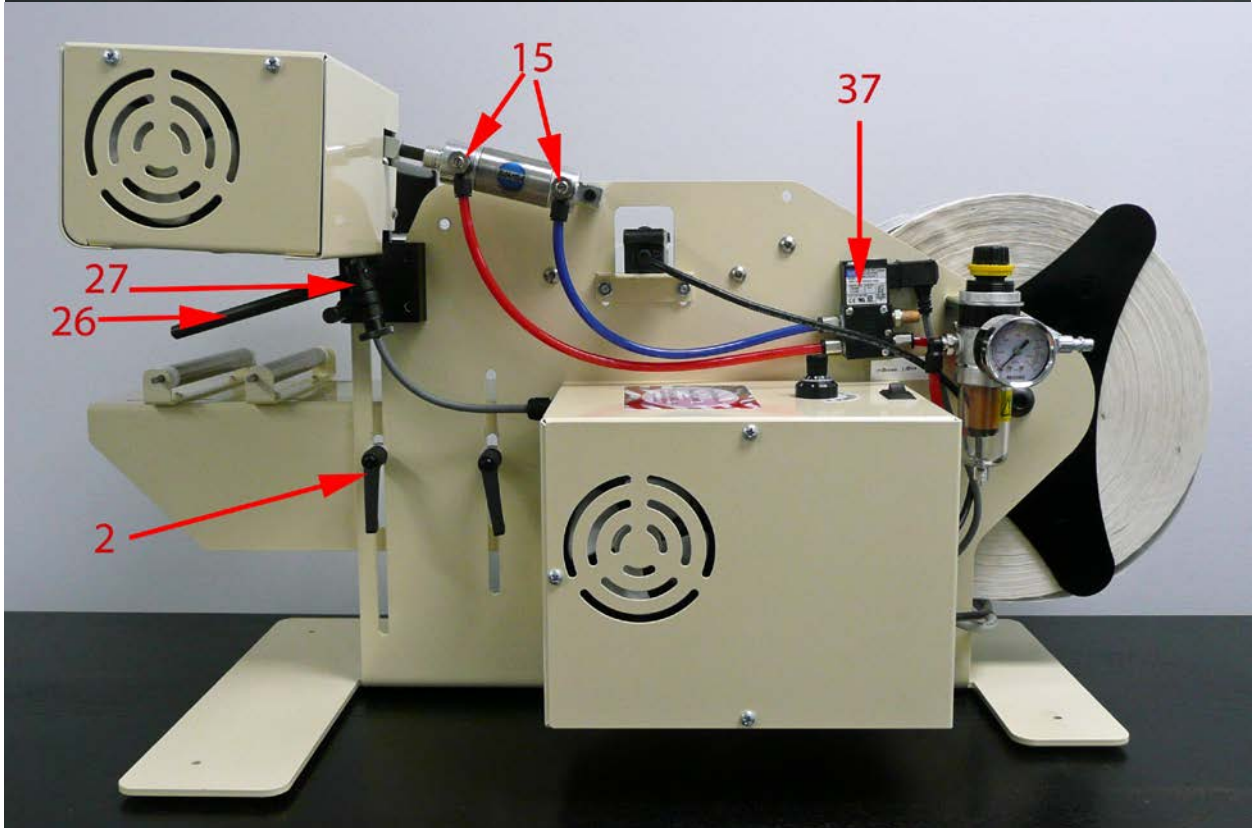
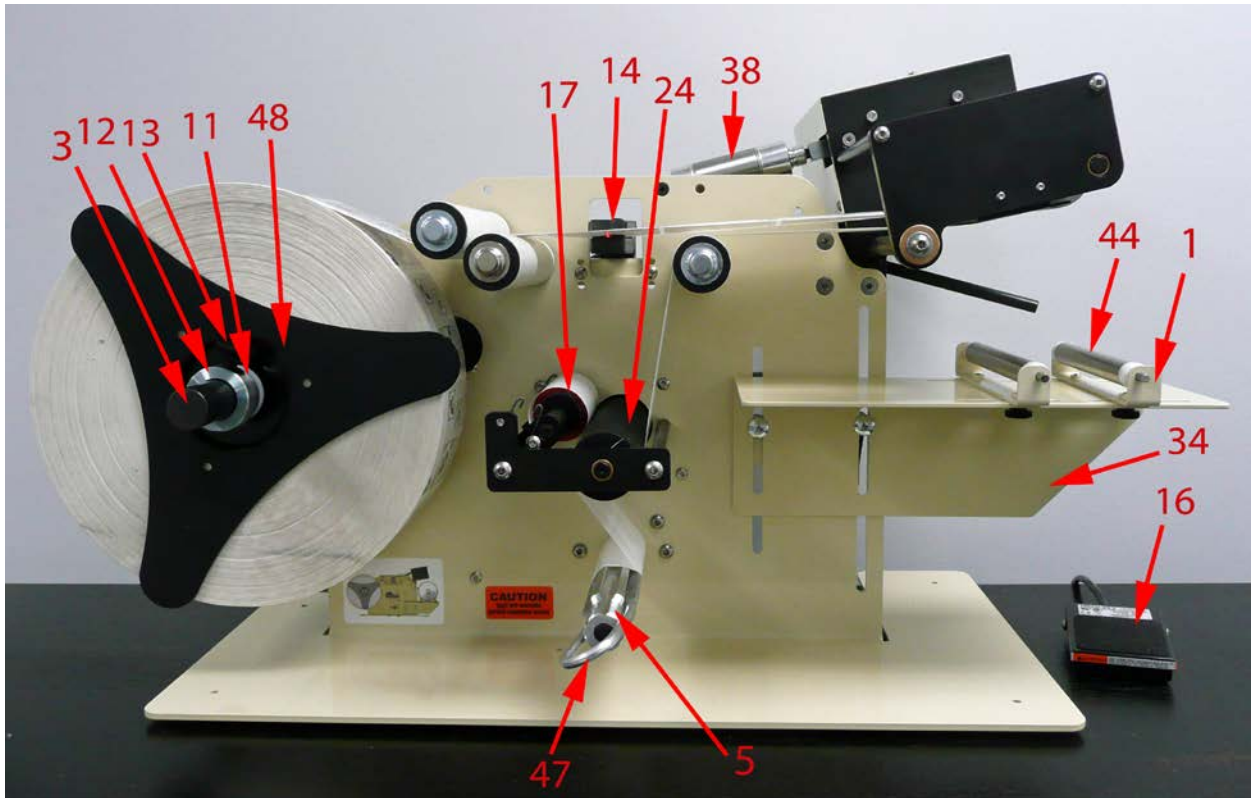



TAL-3100R Parts List

Part #	Description	Item #
11004	Roller Support Bracket	1
11007	Carriage Ratchet Handle	2
11008	Unwind Shaft	3
11010	Carriage Bolt	4
11016	Waste Wind Shaft	5
21031	Gates Drive Belt	6
21026	Motor Spacers	7
21027	Left Torsion Spring	8
21028	Right Torsion Spring	9
25112	Washer	10
25113	Spring	11
26001	Collar	12
26002	Hub Screw	13
30106	Tri-Tronics Photo Eye	14
30143	Flow Control	15
30110	Footswitch	16
31002	Pinch Roller	17
31015	Plastic Bearing	18
31017	Bronze Bushing	19
31029	Bronze Bushing	20
31060	Rewind Bracket	21
31255	Control Board	22
31282	V Belt Tensioner	23
31355	Main Drive Roller	24
31366	Extension Rod	26
31370	3/8" x 3/8" Knuckle	27
31373	V Belt Pulley	28
31380	V Belt Tensioner Roller	29
31408	Rubber Traction Roller	30
31416	Label Advance Dial	31
31417	Label Advance Pot with Wiring	32
31721	Adhesive Backed Rubber Feet	33
31802	Bottle Carriage Table	34
31803	Threaded Guide Rod Support	35
31804	Cylinder Spacer	36
31805	MAC Valve Kit	37
31806	Cylinder and Clevis	38
31818	Peel Plate	39
31832	Flanged Pulley	40
31833	Unflanged Pulley	41



31834	Timing Belt	42
31835	Bronze Bearing	43
37007	Product Rollers	44
40007	On/Off Switch	45
45131	Clip	46
45136	Unwind Disc	47
45155	Fuse Holder	48
45157	Fuse	49
45217	Power Cord	50
72618	Felt Pad	51
76800	Heavy Duty Motor	52
31839	Feed Head Motor (No Brake)	53
81912	Small Cord Grip	54



Optional Accessories

All Purpose Carriage:

The All Purpose Carriage provides greater flexibility and adjustability than the standard bottle carriage. It is especially useful for larger bottles or containers that have lips or ridges that can affect how the bottle rotates in the carriage.



LION 6300 and 8200 Clear Label Photo Eye:

1. Labels must pass under the “Sensing Area” indicator.
2. **Remove one label and place the liner only in the sensor.**
3. Press and hold button with a G inside of a triangle for at least one second. (6300 Only)
3. Press and hold both adjustment arrow buttons at the same time to set the sensor. (8200 Only)



LION 8200



LION 6300



Front and Back Label Option

Setting First Label Advance:

1. Turn both label advance dials counter clockwise to 0.0. Then turn label spacing dial to 5.0.
2. Cycle the machine. Focus only on the first label. Using the 1st label advance pot on the left. Turn the label advance pot clockwise until the gap between the labels stops on the peel edge.

Setting Second Label Advance:

3. Once the first label is dispensing and stopping at the peel edge focus on the second label. Use the 2nd label advance pot on the right to advance the label so it is completely dispensed and the applicator stops at the gap.

Setting Label Spacing:

4. Use the Label Spacing pot to adjust the spacing between the front and back labels. Turning the pot to the + will increase the delay and your spacing between each label. Turning it to the – will decrease your delay and spacing.

TAKE A LABEL

Registered Ink Imprinter:

The registered ink imprinter allows you to imprint an alphanumeric code on the label prior to application to the bottle. This is commonly used for batch codes, expiration dates, or lot codes.



- To adjust the printing location left to right on the web. Loosen two knobs and slide coder to appropriate location.



- To adjust the printing location with the flow of the web. Slide the roller forward or backwards to achieve desired print location.

TAKE A LABEL

Tapered Product Carriage:

The Tapered Product Carriage is designed to assist in the application of labels to tapered bottles. For the tapered carriage to work properly the label must be crescent or arched in shape and match the taper/angle of the bottle.

1. Teach photo eye and set Label Advance per instructions on page 3 and 4.
2. First space two bottle support rollers to support tapered bottle.

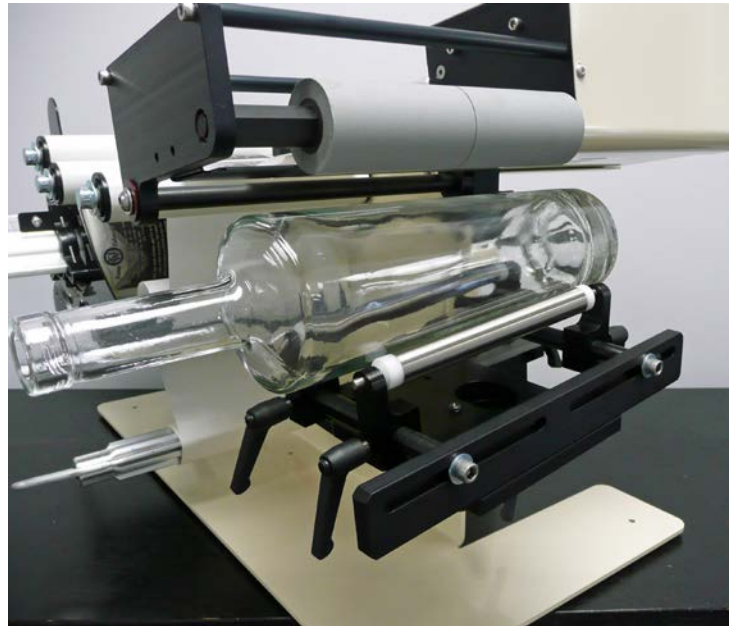

3. Tilt the carriage so when the drive head is lowered it hits the top of the bottle flush. The full length of the rubber product drive roller should hit even and flat across the top of the bottle.



TAKE A LABEL

- Using the adjustment screws (A) in the back of the carriage set the stops for the rotation of the carriage. With the carriage fully rotated and bottomed out against the stop the bottle should match the taper on the edge of the bottle. Once the desired locations are found, use the set screws (B) in the rear of the adjustment blocks to snug onto the threads of the bolt. DO NOT overtighten the set screw as damage can be done to the threads on the bolt.

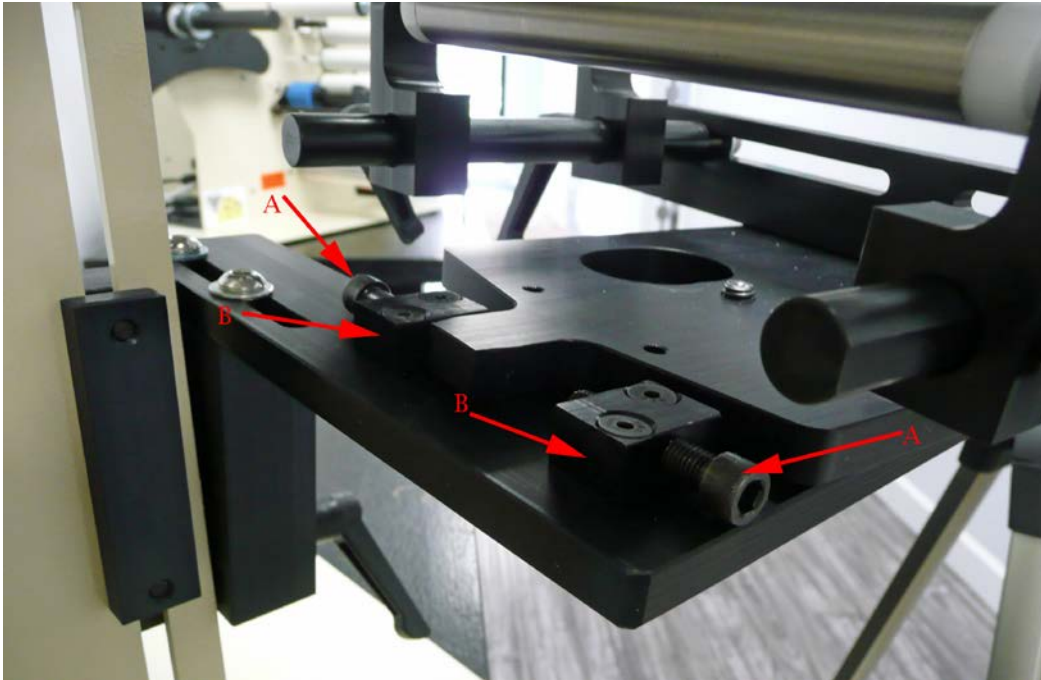

TAKE A LABEL

5. The unit is now be ready to apply the first label. If the first label is not applied square to the bottle, utilize the adjustment screws (A) to make minor adjustments. $\frac{1}{2}$ of a turn on the screw will make a large difference in how the label is applied.

